



## **GENESIS DUO**

### *TWO-PIECE TV SYSTEM FOR MIRRORS*

Installation Guide 1.0

# FOR YOUR RECORD

Dealer name: \_\_\_\_\_

Dealer phone: \_\_\_\_\_

Purchase date: \_\_\_\_\_

Installed by name: \_\_\_\_\_

Installation date: \_\_\_\_\_

It is strongly suggested you keep your sales receipt and warranty details with this document.

## IMPORTANT

Read this document completely before you begin. Carefully consider your level of expertise in installing this product. Make sure you have the necessary tool. Follow all precautions referred to in this document. We recommend this product be installed and configured by a trained installation expert.



## CONTENTS

Important safety instructions _____	2
Caution _____	3
Materials _____	3
Installation _____	3
Video/Audio Connections _____	4
Physical Installation _____	5-6
Troubleshooting _____	7
Technical Support _____	8
Warranty _____	8

# WARNING

---

Installation shall be in accordance with the applicable section of the National Electrical Code, ANSI/NFPA 70, and/or the national Fire Alarm Code, ANSI/NFPA 72, as applicable.

## **FCC Notice**

This equipment has been tested and found to comply with the limits for a Class B digital device, pursuant to Part 15 of the FCC Rules. These limits are designed to provide reasonable protection against harmful interference in a residential installation. This equipment generates, uses, and can radiate radio frequency energy and, if not installed and used in accordance with the instructions, may cause harmful interference to radio communications.

However, there is no guarantee that interference will not occur in a particular installation and the user must understand that interference may not be a result of this product. Proper installation according to the manufacturer's instructions are the best means for reducing or eliminating interference. If this equipment does cause harmful interference to radio or television reception, which can be determined by turning the equipment off and on, the user is encouraged to try to correct the interference by one or more of the following measures:

- Verify proper installation of this product was completed in its entirety, including electrical connections, earth ground, setup procedures, lamp burn-in (if required) and proper operation.
- Reorient or relocate the receiving antenna.
- Increase the separation between the equipment and receiver.
- Connect the equipment into an outlet on a circuit different from that to which the receiver is connected.
- Consult the dealer or an experienced radio/TV technician for help.

# IMPORTANT SAFETY INSTRUCTIONS



1. Read these instructions fully prior to installation.
2. Keep these instructions for future reference.
3. Install and operate in accordance with the manufacturer's instructions.
4. Adhere to all warnings related to this guide and the product.
5. All accessories and included hardware should be considered the only options for installation.
6. Only the included hardware or related accessories available in this package or from Electric Mirror are specified as a genuine for the purpose of installation or operations. No substitutes are considered acceptable.
7. Do not place anything over the unit that blocks its ventilation. Make sure the top and bottom of the unit are free of obstructions.
8. Keep away from heat sources including open flame.

Only use the power supply provided by the manufacturer for connections. DO NOT use an alternate power supply unless approved by Electric Mirror in writing and kept with this manual for future reference.

- This product requires an electrical earth ground for proper electrical performance and safety.

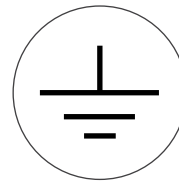

- Keep liquids away from the electronics components.

## ACCESSORY INSTALLATION

All accessories or related products should be completed according to their relative installation guidelines. Once this product is installed, access to connection ports is greatly reduced. Prior planning is strongly recommended.

## FOLLOW THESE INSTALLATION INSTRUCTIONS COMPLETELY

This product is intended for installation with traditional building materials such as metal or wood studs, drywall and connection to quality copper wiring.

This product is intended for installation using electrical standards following local electrical and building codes.

# CAUTION



- Not suitable for high humidity or wet environments.
- Keep away from direct flame and excessive heat.
- Electrical connections must be carried out by a fully qualified electrician in conformance with the National Electrical Code.
- Check with your local codes to determine if the power supply unit requires a GFCI receptacle for the AC/DC adaptor. The receptacle should be located in a readily accessible area in a dry location.

# MATERIALS

- Genesis Duo TV Master Control Unit
- Mirror with mounted TV
- DuoLink Cable bundle
- 2x speaker extension cables (-MS option only, or other audio cable depending on options)
- Power cord (IEC320-C13/Type B)
- Waterproof Remote Control (Guest or Master)



Components sold separately. Due to regional variations, components subject to change without notice.

# INSTALLATION

## VIDEO/AUDIO CONNECTIONS

The diagram below shows the ports on the Genesis Duo TV Master Control box.

*North American Version*

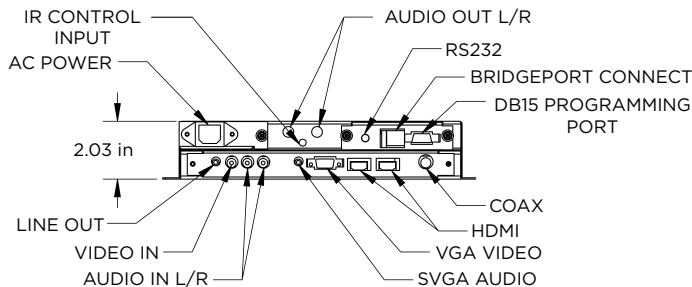

*European Version*

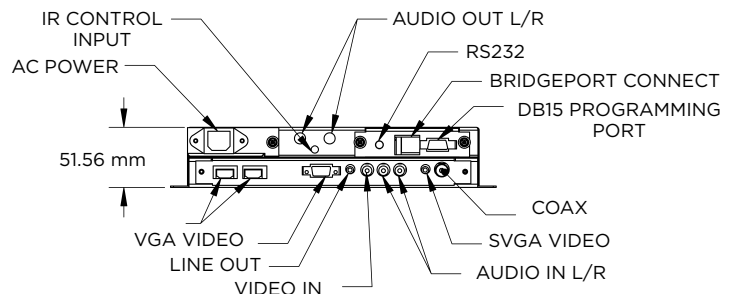

*Note: All versions requires two DuoLink cables (HMD, DV) for connecting between the screen unit and master control unit.*

# VIDEO/AUDIO CONNECTIONS

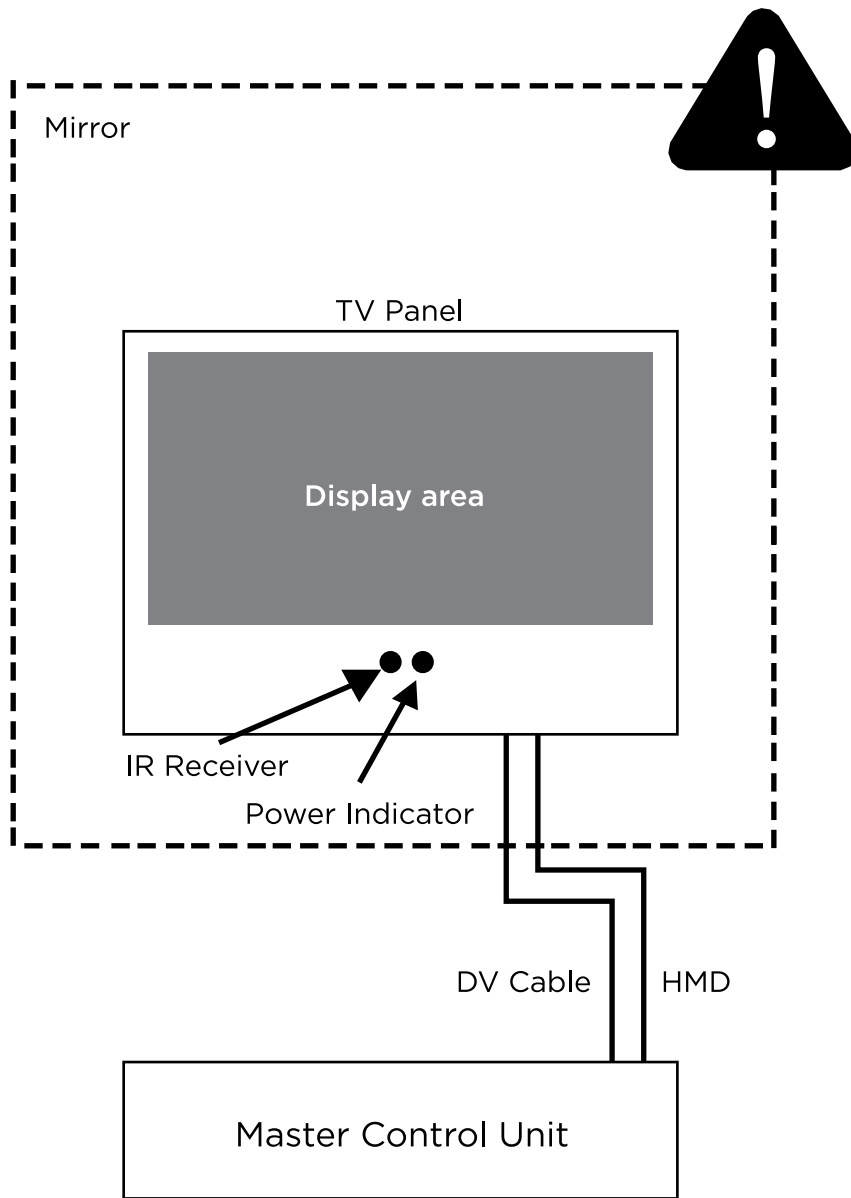

All electronics inputs to this box.  
i.e. HMDI, AC Power, VoD, audio

*The Genesis Duo TV Master Control Unit has two 3.5mm outputs for speaker connections. Regulated for 8 ohms per channel.*

*The unit also has an IR pass-through input for connection to external remote devices. Please contact Electric Mirror for further information.*

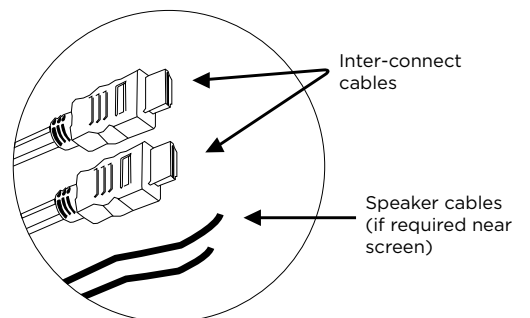

# PHYSICAL INSTALLATION



Connect the system components prior to installation. Test the system for power-up, remote control functionality and speaker

- **Mount the Genesis Duo TV Master Control Unit in a dry location and secure using screws through mounting flanges on case. May be mounted in any orientation provided it is securely fastened.**

**Determine the location of the unit on the wall. Refer to the Sales Aid specification for product dimensions.**

1. **Select an appropriate location for the Genesis Duo TV Master Control Unit.**

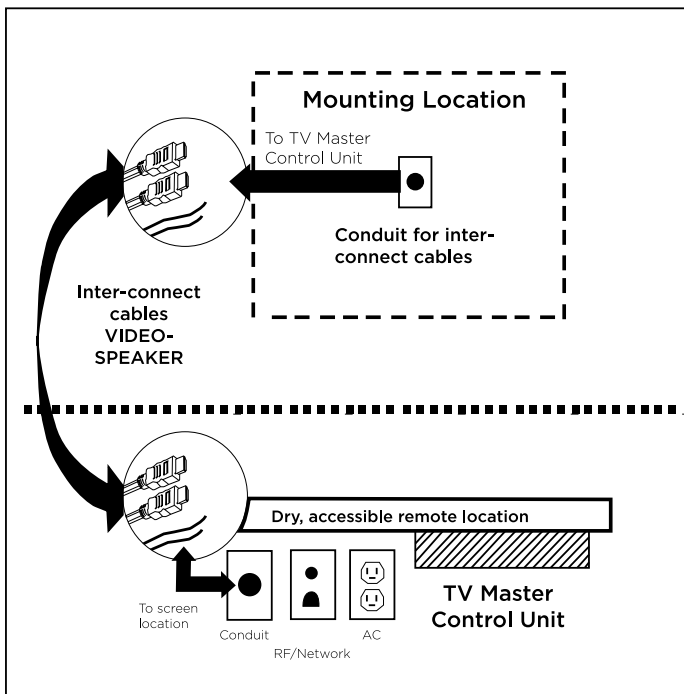

Any device you want to use for input to your two part TV system need to be plugged into the Genesis Duo TV Master Control Unit, so make sure it is accessible. This includes set top boxes, DVD or Blu-ray players, media players, cable boxes, computers, VCRs or mobile devices.

## ELECTRIC MIRROR RECOMMENDATIONS

**Mount the Genesis Duo TV Master Control Unit:**

- **In the space above removable ceiling tiles in accordance to local building and electrical codes**
  - **Any dry and easily accessible location**
  - **Into studs for on-wall stability (wall mount)**
  - **A nearby linen or service closet**
  - **Genesis Duo TV Master Control Unit should not be placed behind an inaccessible location.**
- **The Genesis Duo TV Master Control Unit must be located near an accessible power outlet, and within reach of a set top box or audio/visual source**

# PHYSICAL INSTALLATION

- Ensure that there is a usable cable path between the box location and the screen location. If a conduit is required, a size of 1" or greater is required.

- **Warning:** Check your local building code whether conduit is required, or in-wall rated cables are needed.



2. **Route (speaker, video and power) cables from Genesis Duo TV Master Control Unit location to screen location. Follow all NEC guidelines. Check if conduit is required by local regulations.**

- Speaker options may include standard speakers or ceiling mounted speakers.

- Plug the power supply cable of the AC/DC Adaptor into the outlet. A light by the DuoLink cable will indicate that the unit is powered correctly.

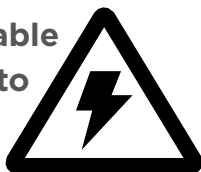

- Leave 4 to 5 extra feet (for all cables) loose at the screen location for ease of installation.
- The cables should not be cut, shortened or lengthened in any way. Doing so may cause damage to the unit and voids all warranty.

3. Insert cables into Screen Unit immediately prior to hanging.
4. Turn on your TV unit and enjoy!

## NOTICES

- Some features are dependent upon the broadcasting of information by local off-air and cable TV channels.
- Specifications are subject to change without notice.
- HDMI, the HDMI logo, and High Definition Multimedia Interface are trademarks or registered trademarks of HDMI Licensing LLC
- ELECTRIC MIRROR and the Electric Mirror logo is a registered trademark. All rights reserved.



# TROUBLESHOOTING

---

## Audio is not working

- Make sure the volume is on.
- Make sure the 3.5mm male connections are in the correct location and engaged fully. Turn connections a 1/4-turn if static audio occurs.

## Can I use my TV in wet conditions?

- No. Electric Mirror recommends the unit to be placed in a dry, low humidity location. Excessive hot or cold temperature areas are not recommended.

## How should I clean my TV?

- Warm water with a soft, lint free cloth.

## My TV does not turn on

- Check power supply for proper connection. A light on the Genesis Duo TV Master Control Unit should be illuminated when connected to line power.
- Check the Inter-connect cable connections to make sure they fully connect to both the Genesis Duo TV Master Control Unit and the Screen Unit.
- Check the battery inside the remote control by removing the plastic battery cover.

## Video connection creates a grainy or unclear image

- Check connection at video source and at TV screen for proper connection.
- Make sure the video cable is not damaged in any way.

## What should I do if I lose the remote?

- Contact Electric Mirror for replacement details.

## Where are the best locations for Genesis Duo TV Master Control Unit installation?

- A dry, dust-free, easily accessible location.

## Should I aim my remote at my screen, or at the Genesis Duo TV Master Control Unit?

- The IR receiver is located in the screen unit. The remote control should be aimed at the screen.
- The Genesis Duo TV Master Control Unit does not have IR input, and cannot be turned on or used unless it is plugged into the screen with the DuoLink cables and using the Remote Control.

## Can I replace my DuoLink cables with ones that I buy from the store if I need a different length?

- Contact Electric Mirror for limitations and cable rating information.
- Contact Electric Mirror for other DuoLink cable length options.

# TECHNICAL SUPPORT

---

**For support, please use this contact information:**

**Electric Mirror, Inc.  
11831 Beverly Park Road  
Building D  
Everett, WA 98204 USA  
t: 425 776-4946  
f: 425 491-8200**

# WARRANTY

---

**For warranty information, visit [www.electricmirror.com/warranty/](http://www.electricmirror.com/warranty/)**

**All Rights Reserved. All designs, engineering drawings, images, photographs, logos and written material that appear in this document are protected by copyright. The information contained in this document is the sole property of Electric Mirror® LLC. Any reproduction in part or in whole without written permission from Electric Mirror is prohibited.**