

FUSION™

LIGHTED MIRROR

Installation Instructions

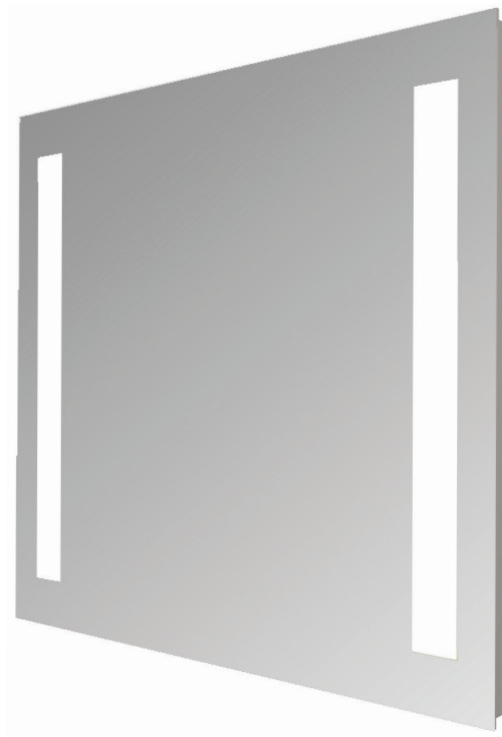

IMPORTANT SAFETY INSTRUCTIONS

Must be installed by a qualified technician.

Read these installation instructions. Keep these instructions for future use. Follow all instructions. Install in accordance with manufacturer's instructions.

FAILURE TO FOLLOW INSTRUCTIONS COULD RESULT IN DEATH OR SERIOUS INJURY.

FAILURE TO FOLLOW INSTRUCTIONS VOIDS WARRANTY.

This luminaire must be mounted or supported independently of an outlet box. Make sure electrical connections are wired correctly. Power and neutral wires must be connected to the luminaire disconnect. Insert the power wire into the black colored insert and the neutral wire into the white colored insert. The ground must be connected. Do not defeat the safety purpose of the grounding wire inside the chassis. The chassis must be grounded to avoid possible electrical shock.

CAUTION

READ ALL INSTRUCTIONS PRIOR TO INSTALLATION

WARNING:

TO PREVENT INJURY, THE MIRROR MUST BE INSTALLED IN ACCORDANCE WITH THE MANUFACTURER'S INSTRUCTIONS

CAUTION: THE ONLY USER SERVICEABLE PARTS INSIDE ARE THE LAMPS. OTHER COMPONENTS MUST BE SERVICED BY QUALIFIED ELECTRICIANS. LUMINAIRE DISCONNECT MUST BE DISCONNECTED PRIOR TO COMPONENT SERVICING

UNPACKING YOUR LIGHTED MIRROR

Verify Contents

Prior to installation, unpack items and verify contents. The lighted mirror comes with 2 boxes and lamps:

BOX 1: CHASSIS ASSEMBLY

Label will include part number: FUS-(size)-C

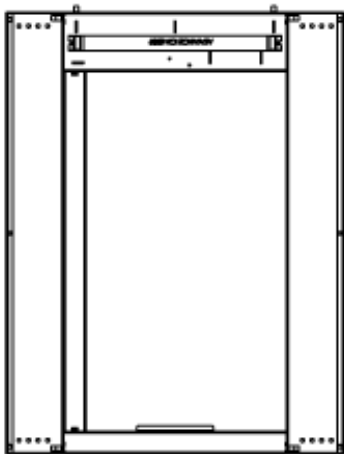

BOX 2: MIRROR ASSEMBLY WITH INTEGRAL HANGERS

Label will include part number: FUS-(size)-M

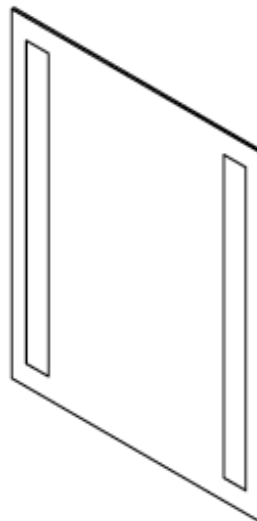

Front View

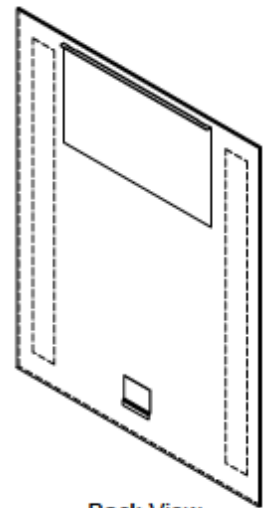

Back View

INSTALLATION

1. MOUNT THE CHASSIS ON THE WALL

Before mounting chassis on wall, identify mirror location on wall. Drill marks should be measured from the edge of the mirror NOT FROM EDGE OF CHASSIS. There are multiple mounting holes that can be chosen from to accommodate mounting locations. The chassis shall be installed with a minimum of (4) 1/4" x 1-1/2" lag screws or other engineering approved fasteners. Use wall anchors or reinforced backing areas to support chassis. See individual product specifications for mounting hole locations.

2. INSTALL LAMPS

Lamps should fit within the lamp holders provided in chassis. Rotate lamps to lock into place.

3. WIRING DETAILS

Please note, all electrical installations should be carried out by a fully qualified electrician in conformance with the National Electrical Code and local building codes.

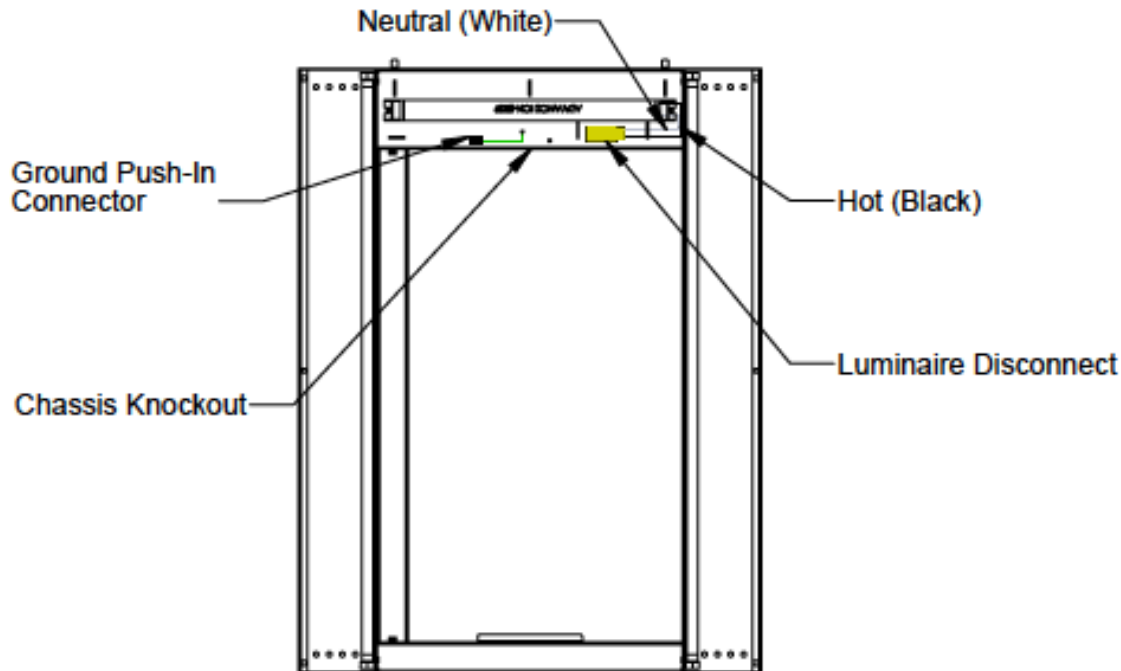

4. POWER CONNECTION

Before proceeding to power supply wiring, make sure the MC cable is brought in through the wall and into the chassis knockout.

READ AND COMPLY WITH THE INSTRUCTIONS ON THE DIMMING CONTROLLER.

Insert ground wire in the grounded connector. Insert the hot and neutral wires into the luminaire disconnect.

The hot wire is inserted into the black port (number 1) and the neutral wire is inserted into the white port (number 2).

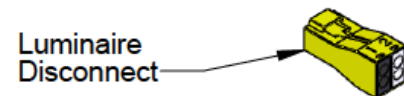

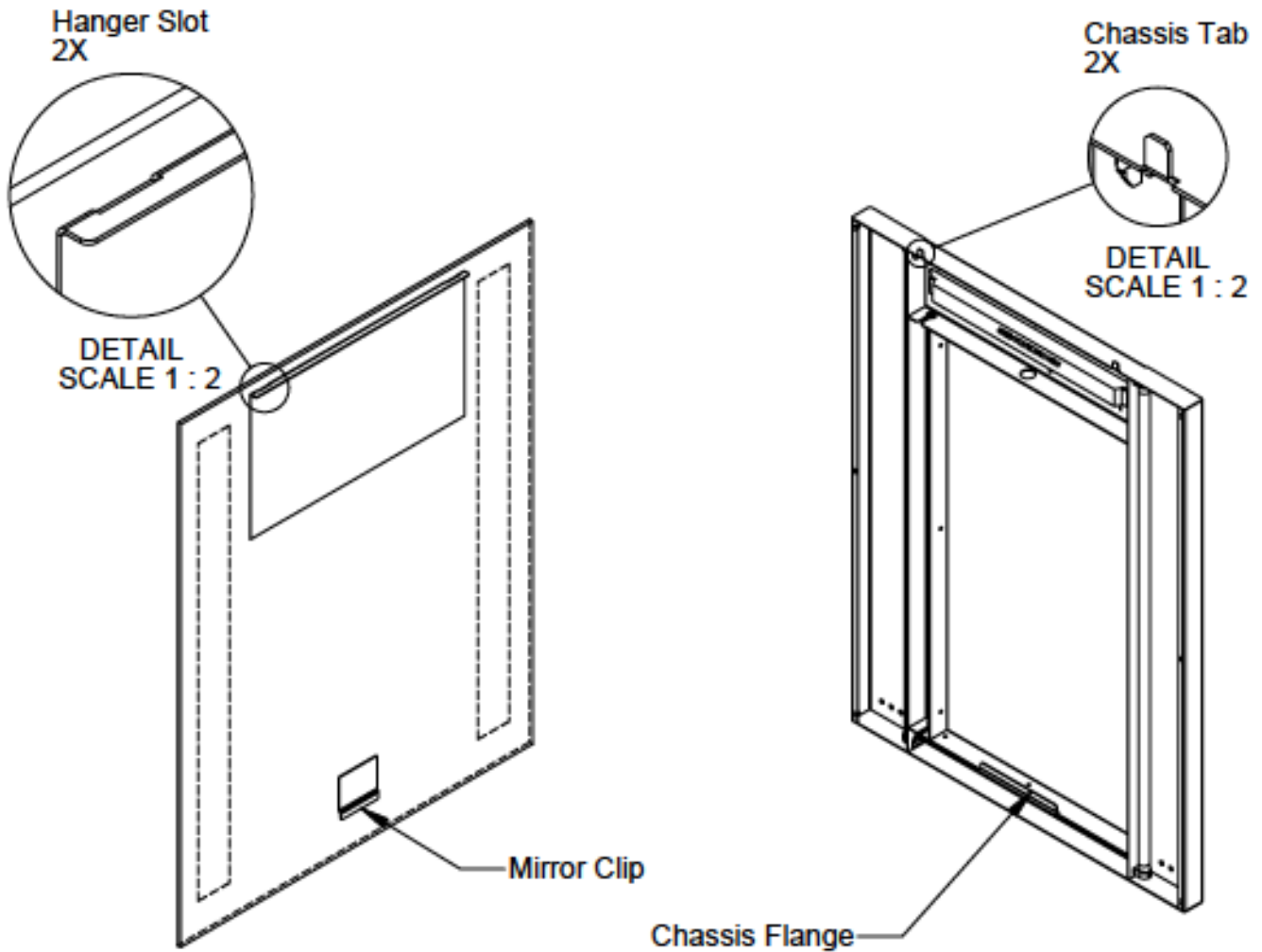

5. MIRROR MOUNTING

After wiring process is completed, mirror is ready to be hung on the chassis. The weight of the mirror is supported at the top of the chassis. The mirror clip, at the bottom of mirror, is used to keep the mirror from moving away from the wall. Hang mirror on chassis by aligning tabs on chassis through mirror hanger slots while holding the mirror against the chassis. Slide the mirror down inserting the chassis tabs into the hanger slots. Make sure all tabs are engaged through hanger slots and the mirror clip overlaps the chassis flange.